

Drawing packet assignment #14 - Drawing #14

1. Construct 2D model as per packet instructions within Mastercam.

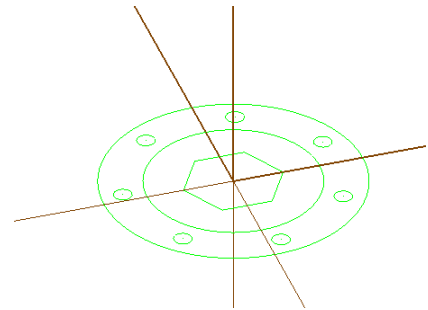

2. Construct 3D solid model.

- Solids
- Extrude...

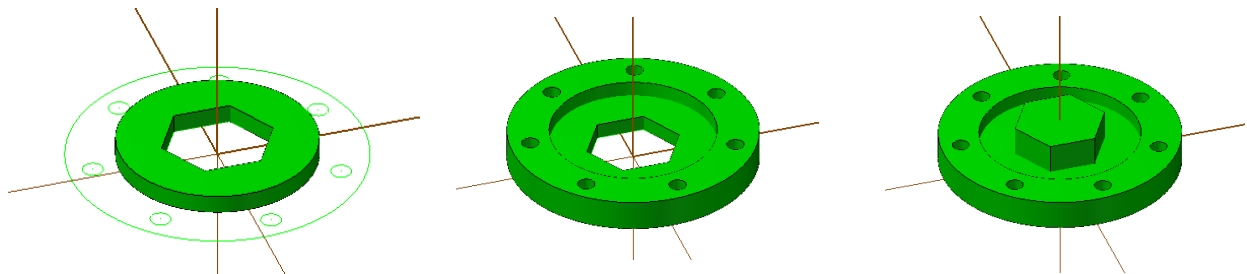

3. Set-Up WCS (Workpiece Coordinate System)

Establish:

- Machine Type (Mill)

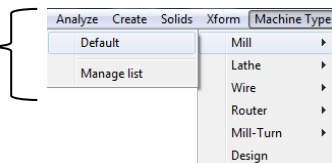

- Bounding-Box
 1. Operations manager
 2. Mill Group, Files
 3. Stock Setup

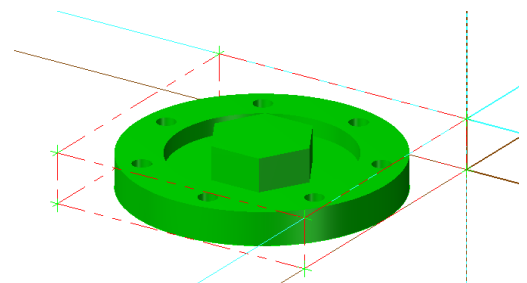
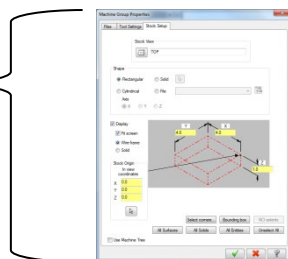

- Origin
- T- Plane
- C - Plane
 1. WCS
 2. View manager

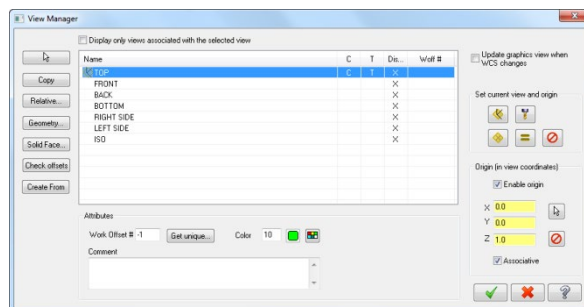

4. Create toolpaths:

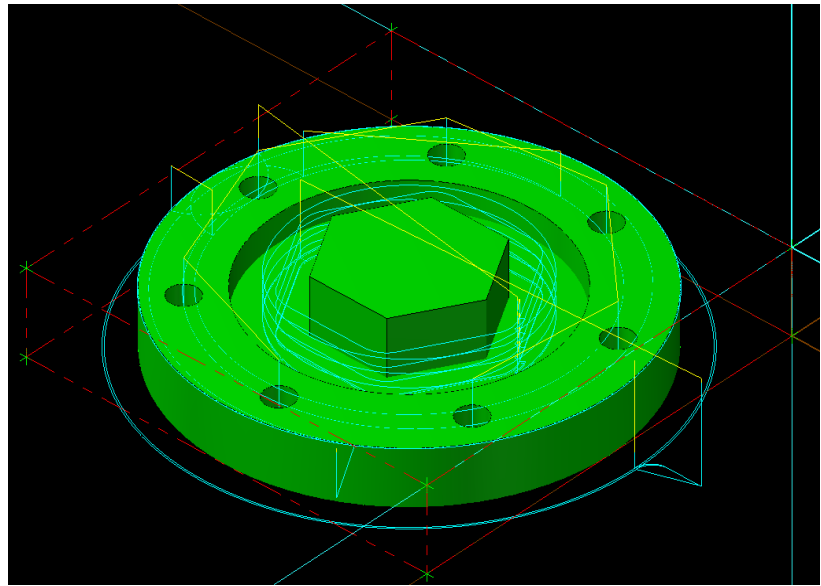
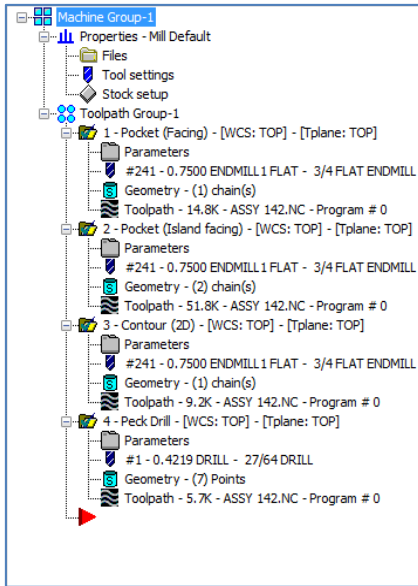

5. Verify machine toolpaths with virtual simulator:

